

NEW: ENVIRONMENTAL PRODUCT DECLARATIONS (EPDs) NOW AVAILABLE

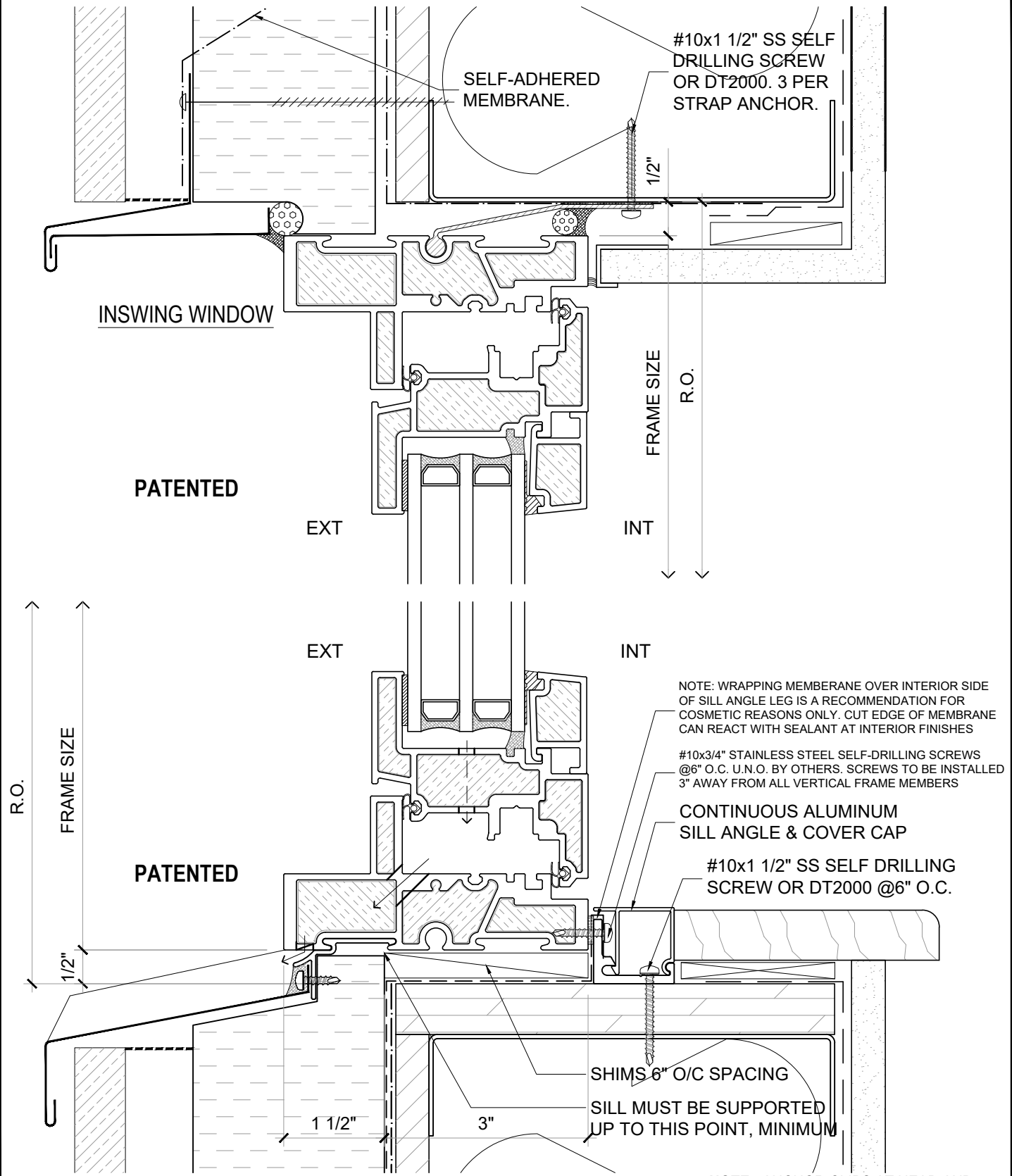

NOTE: THIS DRAFT DETAIL IS FOR GENERAL ARRANGEMENT PURPOSES ONLY, AND DOES NOT NECESSARILY REPRESENT A DETAIL THAT IS APPROPRIATE FOR A SPECIFIC PROJECT. PRODUCTS AND ACCESSORIES PROVIDED BY CASCADIA MUST BE CONFIRMED FOR SPECIFIC PROJECTS.

NOTE: ANCHOR CLIPS AT HEAD AND JAMBS ARE INTERMITTENT

CASCADIA WINDOWS LTD.
#101-5350 275TH STREET
LANGLEY, BC, CANADA V4W 0C1

DRAWING TITLE: **UNIVERSAL SERIES © - TYP. WINDOW HEAD+SILL**
RAINSCREEN WALL ASSEMBLY, EXTERIOR INSULATION

DRAWING NO.: **W-1.01T**

SCALE: 6" = 1'-0"

PATENTED

DATE: 21 AUGUST, 2020

DRAWN BY: CP

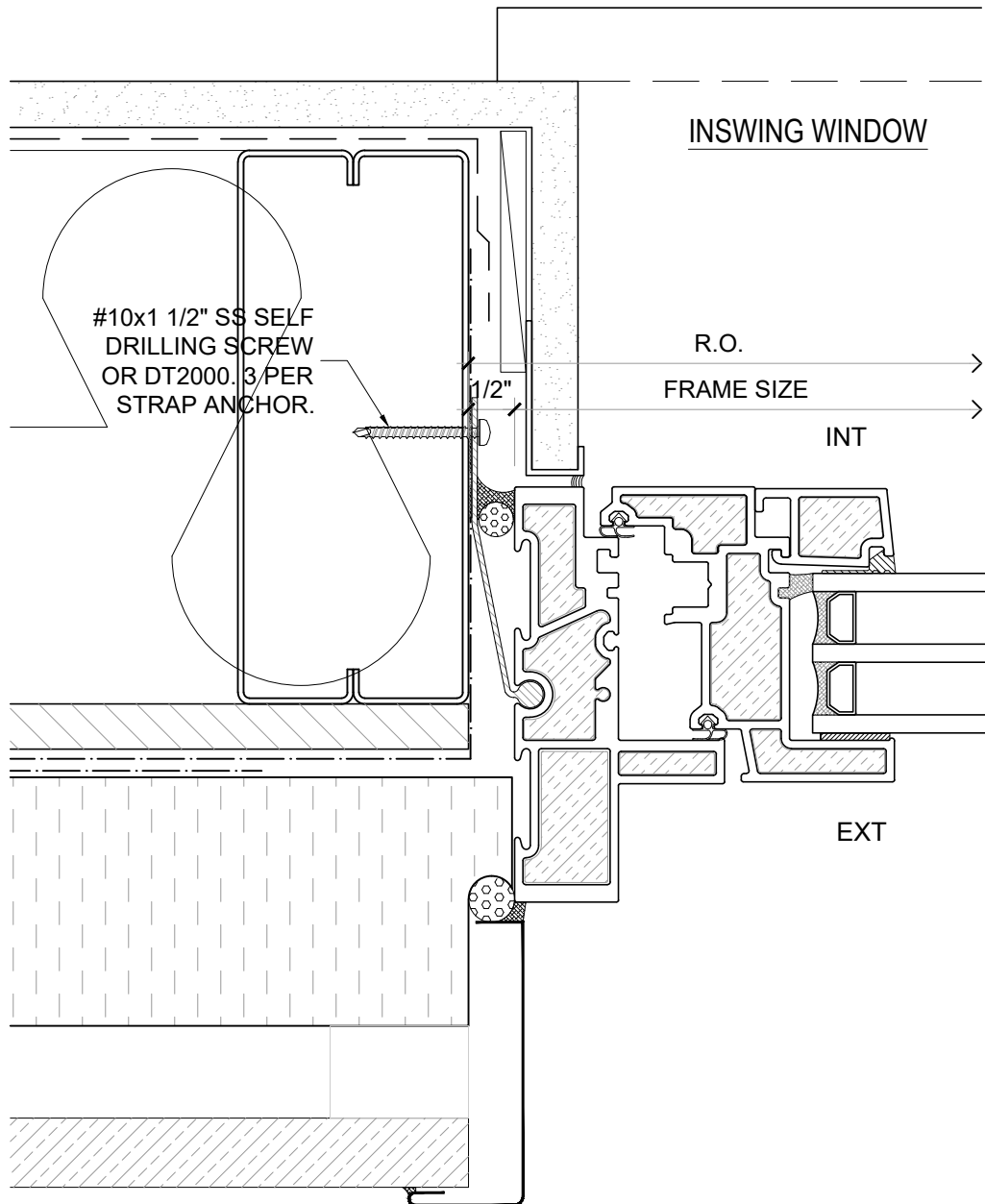

PATENTED

NOTE: THIS DRAFT DETAIL IS FOR GENERAL ARRANGEMENT PURPOSES ONLY, AND DOES NOT NECESSARILY REPRESENT A DETAIL THAT IS APPROPRIATE FOR A SPECIFIC PROJECT. PRODUCTS AND ACCESSORIES PROVIDED BY CASCADIA MUST BE CONFIRMED FOR SPECIFIC PROJECTS.

NOTE: ANCHOR CLIPS AT HEAD AND JAMBS ARE INTERMITTENT

CASCADIA WINDOWS LTD.
 #101-5350 275TH STREET
 LANGLEY, BC, CANADA V4W 0C1

DRAWING TITLE: **UNIVERSAL SERIES ® - TYPICAL WINDOW JAMB**
 RAINSCREEN WALL ASSEMBLY, EXTERIOR INSULATION

DRAWING NO.:
W-1.02T

SCALE: 6" = 1'-0"

PATENTED

DATE: 21 AUGUST, 2020

DRAWN BY: CP

NEW: ENVIRONMENTAL PRODUCT DECLARATIONS (EPDs) NOW AVAILABLE

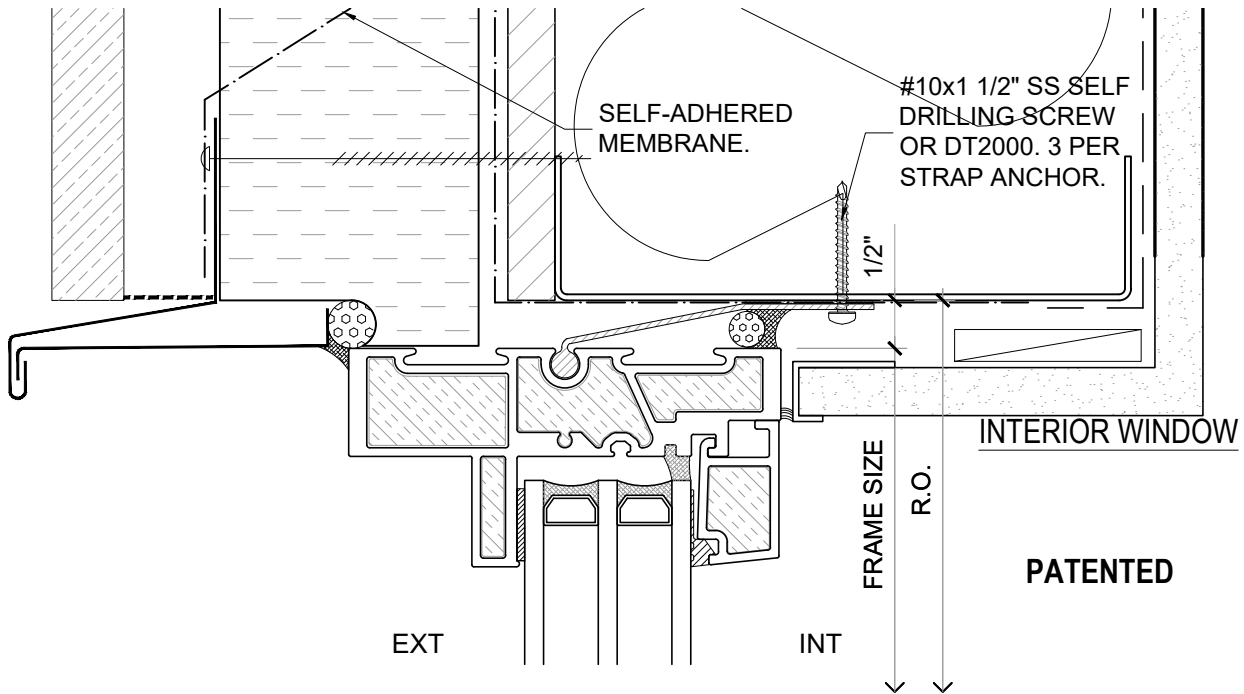

NOTE: WRAPPING MEMBRANE OVER INTERIOR SIDE OF SILL ANGLE LEG IS A RECOMMENDATION FOR COSMETIC REASONS ONLY. CUT EDGE OF MEMBRANE CAN REACT WITH SEALANT AT INTERIOR FINISHES

#10x3/4" STAINLESS STEEL SELF-DRILLING SCREWS @6" O.C. U.N.O. BY OTHERS. SCREWS TO BE INSTALLED 3" AWAY FROM ALL VERTICAL FRAME MEMBERS

CONTINUOUS ALUMINUM SILL ANGLE & COVER CAP

#10x1 1/2" SS SELF DRILLING SCREW OR DT2000 @6" O.C.

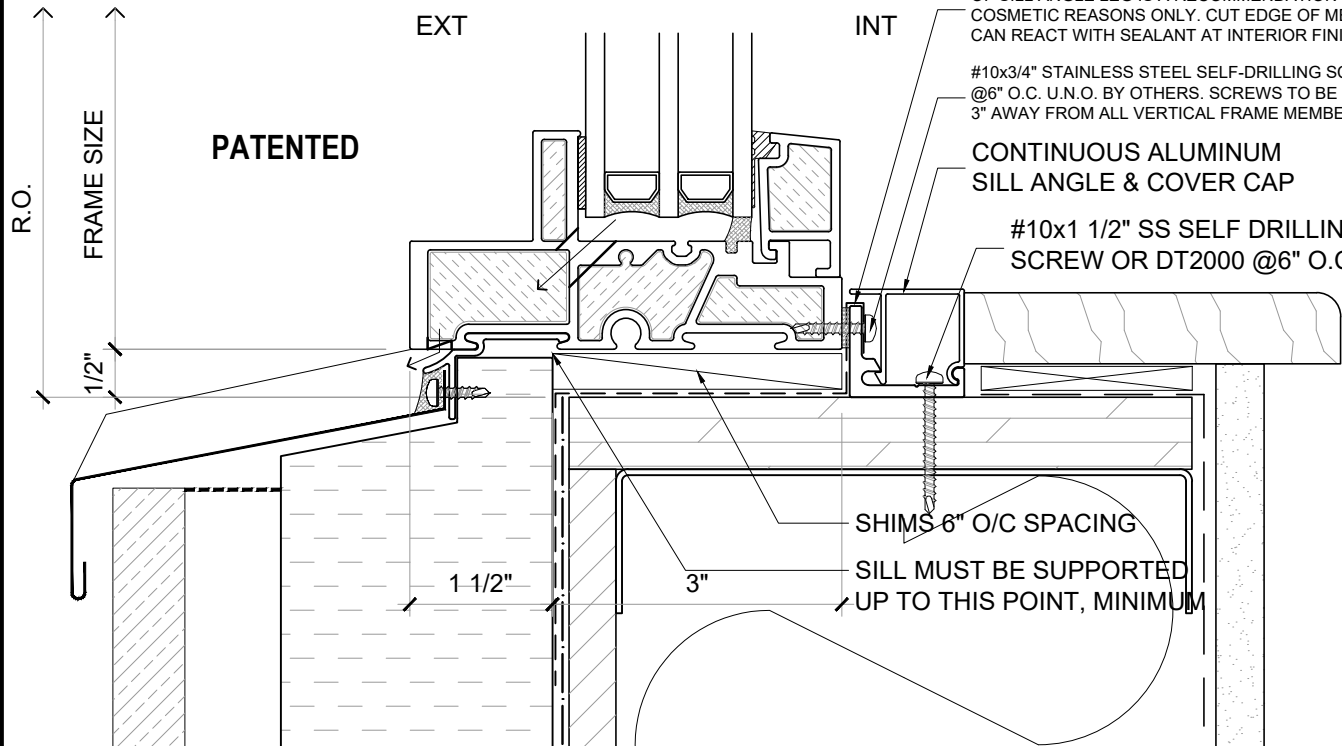

NOTE: "INTERIOR" & "EXTERIOR" REFERS TO THE WINDOW BEING INTERIOR OR EXTERIOR GLAZED

NOTE: THIS DRAFT DETAIL IS FOR GENERAL ARRANGEMENT PURPOSES ONLY, AND DOES NOT NECESSARILY REPRESENT A DETAIL THAT IS APPROPRIATE FOR A SPECIFIC PROJECT. PRODUCTS AND ACCESSORIES PROVIDED BY CASCADIA MUST BE CONFIRMED FOR SPECIFIC PROJECTS.

NOTE: ANCHOR CLIPS AT HEAD AND JAMBS ARE INTERMITTENT

CASCADIA WINDOWS LTD.
#101-5350 275TH STREET
LANGLEY, BC, CANADA V4W 0C1

DRAWING TITLE: UNIVERSAL SERIES [®] - TYP. WINDOW HEAD+SILL
RAINSCREEN WALL ASSEMBLY, EXTERIOR INSULATION

DRAWING NO.: W-1.03T

SCALE: 6" = 1'-0"

PATENTED

DATE: 21 AUGUST, 2020

DRAWN BY: CP

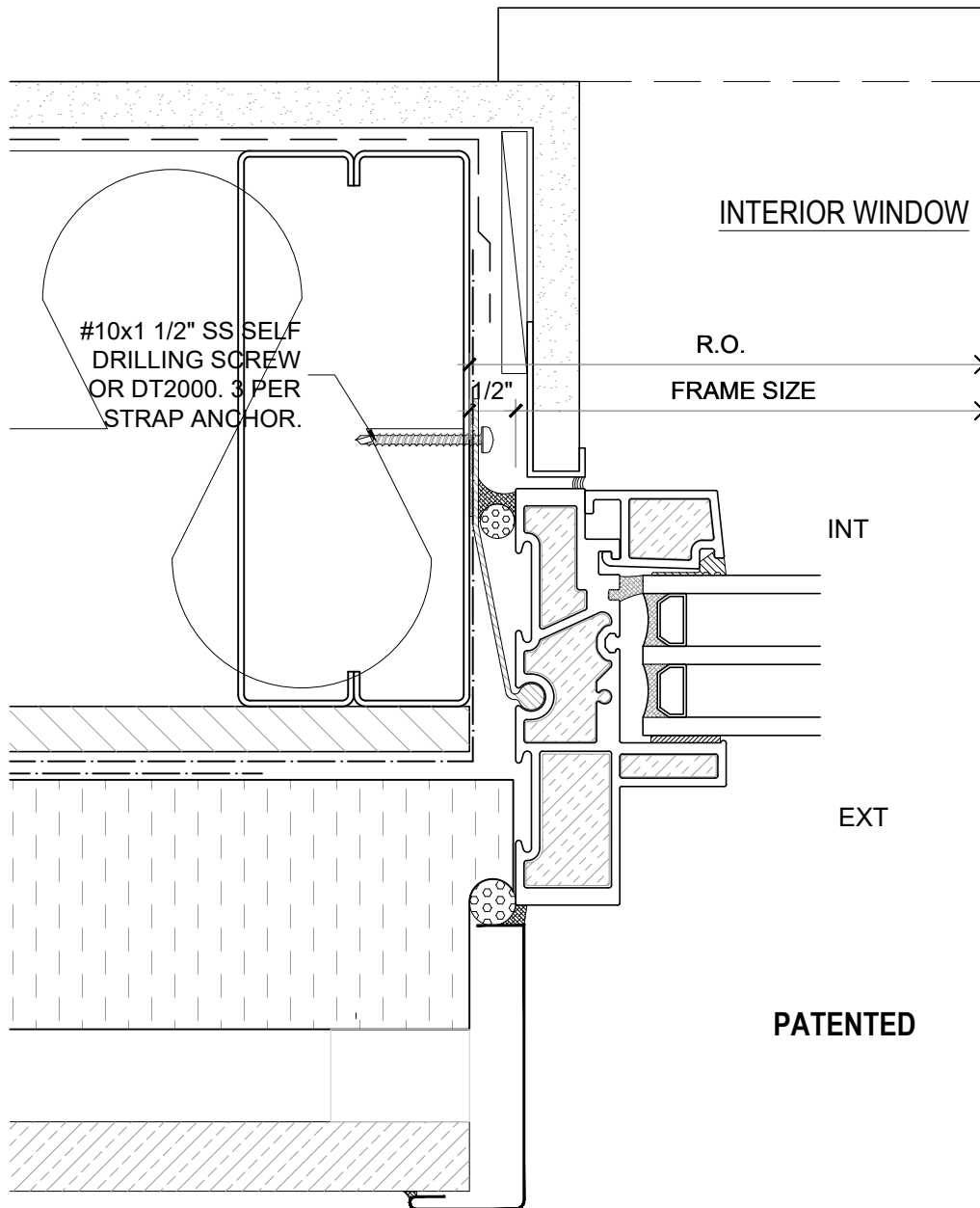

NOTE: "INTERIOR" & "EXTERIOR"
REFERS TO THE WINDOW BEING
INTERIOR OR EXTERIOR GLAZED

NOTE: THIS DRAFT DETAIL IS FOR GENERAL ARRANGEMENT PURPOSES ONLY, AND DOES NOT
NECESSARILY REPRESENT A DETAIL THAT IS APPROPRIATE FOR A SPECIFIC PROJECT. PRODUCTS AND
ACCESSORIES PROVIDED BY CASCADIA MUST BE CONFIRMED FOR SPECIFIC PROJECTS.

NOTE: ANCHOR CLIPS AT HEAD AND
JAMBS ARE INTERMITTENT

CASCADIA WINDOWS LTD.
#101-5350 275TH STREET
LANGLEY, BC, CANADA V4W 0C1

DRAWING TITLE: **UNIVERSAL SERIES © - TYPICAL WINDOW JAMB
RAINSCREEN WALL ASSEMBLY, EXTERIOR INSULATION**

DRAWING NO.:
W-1.04T

SCALE: 6" = 1'-0"

PATENTED

DATE: 21 AUGUST, 2020

DRAWN BY: CP

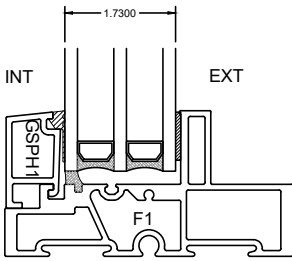

TRIPLE GLAZED
GLAZING STOP

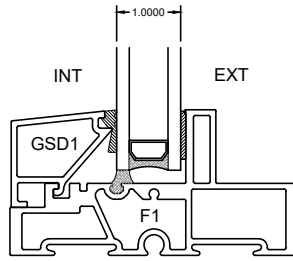

DOUBLE GLAZED
GLAZING STOP

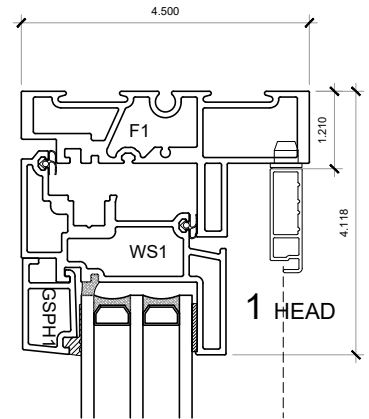

1 HEAD

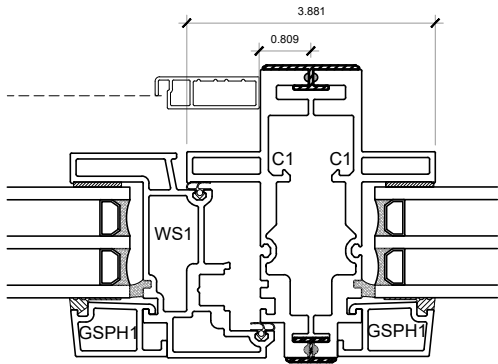

4 COUPLED MULLION

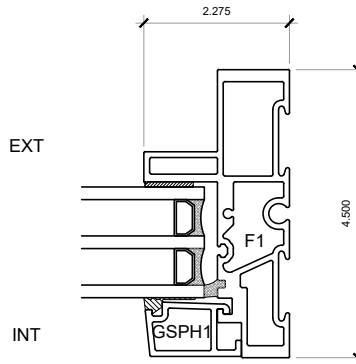

3 FIXED JAMB

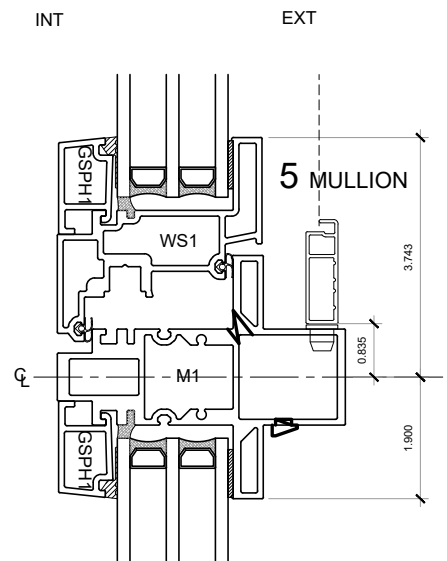

5 MULLION

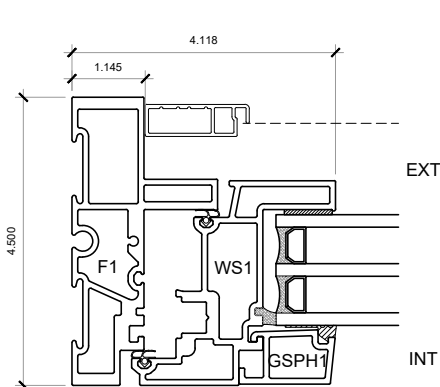

6 OPERABLE JAMB

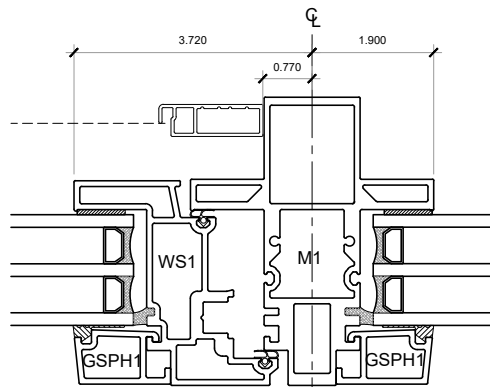

5 MULLION

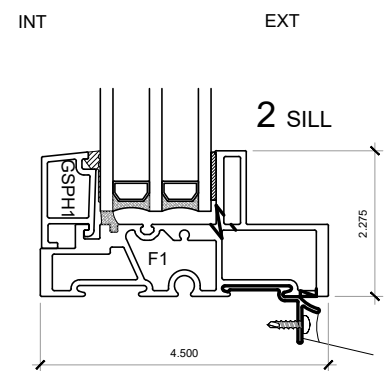

2 SILL

PATENTED

NOTE: THIS DRAFT DETAIL IS FOR GENERAL ARRANGEMENT PURPOSES ONLY, AND DOES NOT NECESSARILY REPRESENT A DETAIL THAT IS APPROPRIATE FOR A SPECIFIC PROJECT. PRODUCTS AND ACCESSORIES PROVIDED BY CASCADIA MUST BE CONFIRMED FOR SPECIFIC PROJECTS.

CASCADIA WINDOWS LTD.
#101-5350 275TH STREET
LANGLEY, BC, CANADA V4W 0C1

DRAWING
TITLE:

UNIVERSAL SERIES ® - INSWING WINDOW
PRODUCT DRAWING

DRAWING NO.:

W-2.01T

SCALE: 4" = 1'-0"

PATENTED

DATE: 21 AUGUST, 2020

DRAWN BY: CP