

**NOTE:** THIS DRAFT DETAIL IS FOR GENERAL ARRANGEMENT PURPOSES ONLY, AND DOES NOT NECESSARILY REPRESENT A DETAIL THAT IS APPROPRIATE FOR A SPECIFIC PROJECT. PRODUCTS AND ACCESSORIES PROVIDED BY CASCADIA MUST BE CONFIRMED FOR SPECIFIC PROJECTS.

**NOTE:** NAIL FLANGE IS CONTINUOUS

CASCADIA WINDOWS LTD.  
 #101-5350 275TH STREET  
 LANGLEY, BC, CANADA V4W 0C1

DRAWING TITLE: UNIVERSAL SERIES - WINDOW HEADS  
 STANDARD NAIL FLANGE INSTALLATION (CW-NF1)

DRAWING NO.: NF-1.01

SCALE: 6" = 1'-0"

PATENTED

DATE: 16 MAY, 2018

DRAWN BY: CP

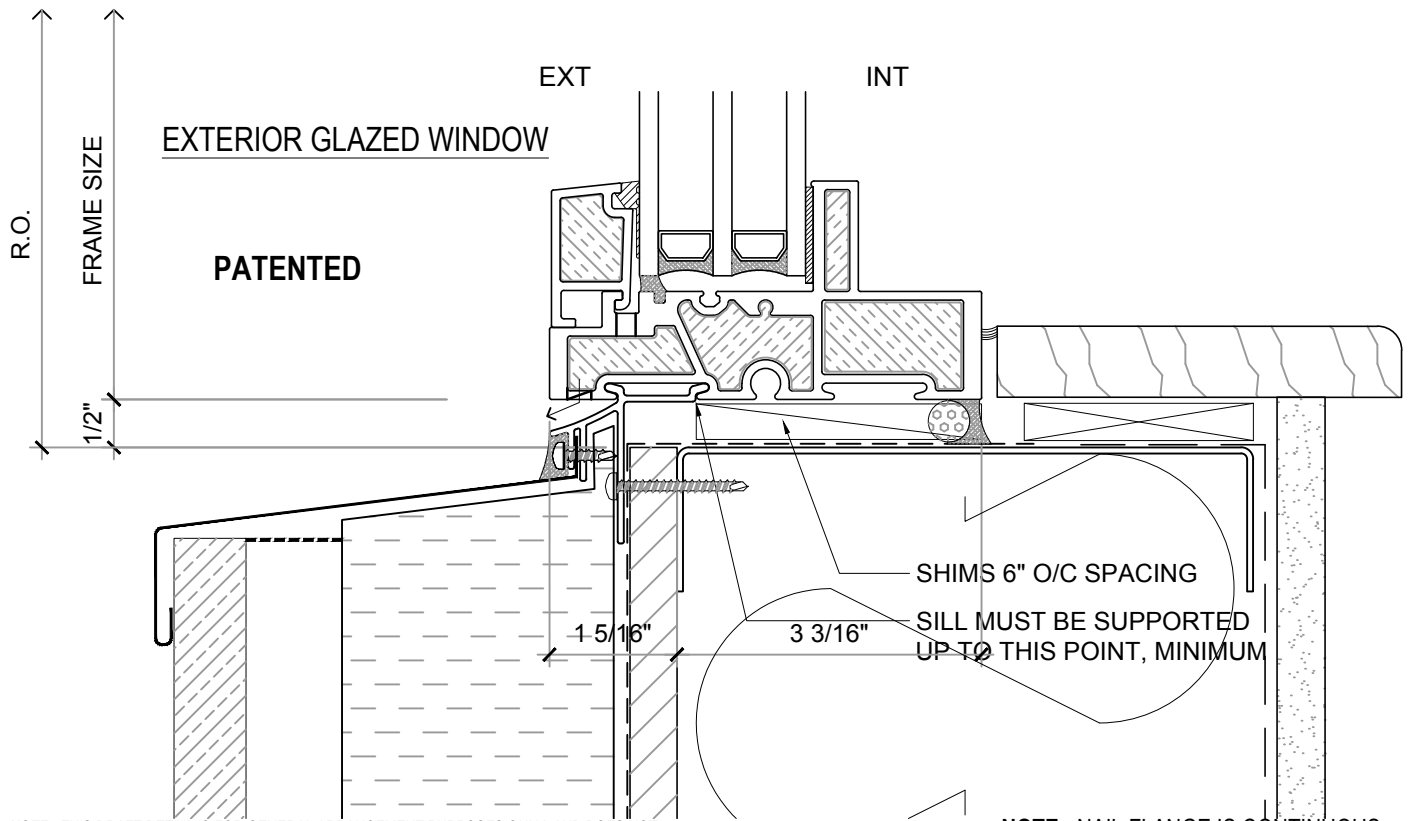
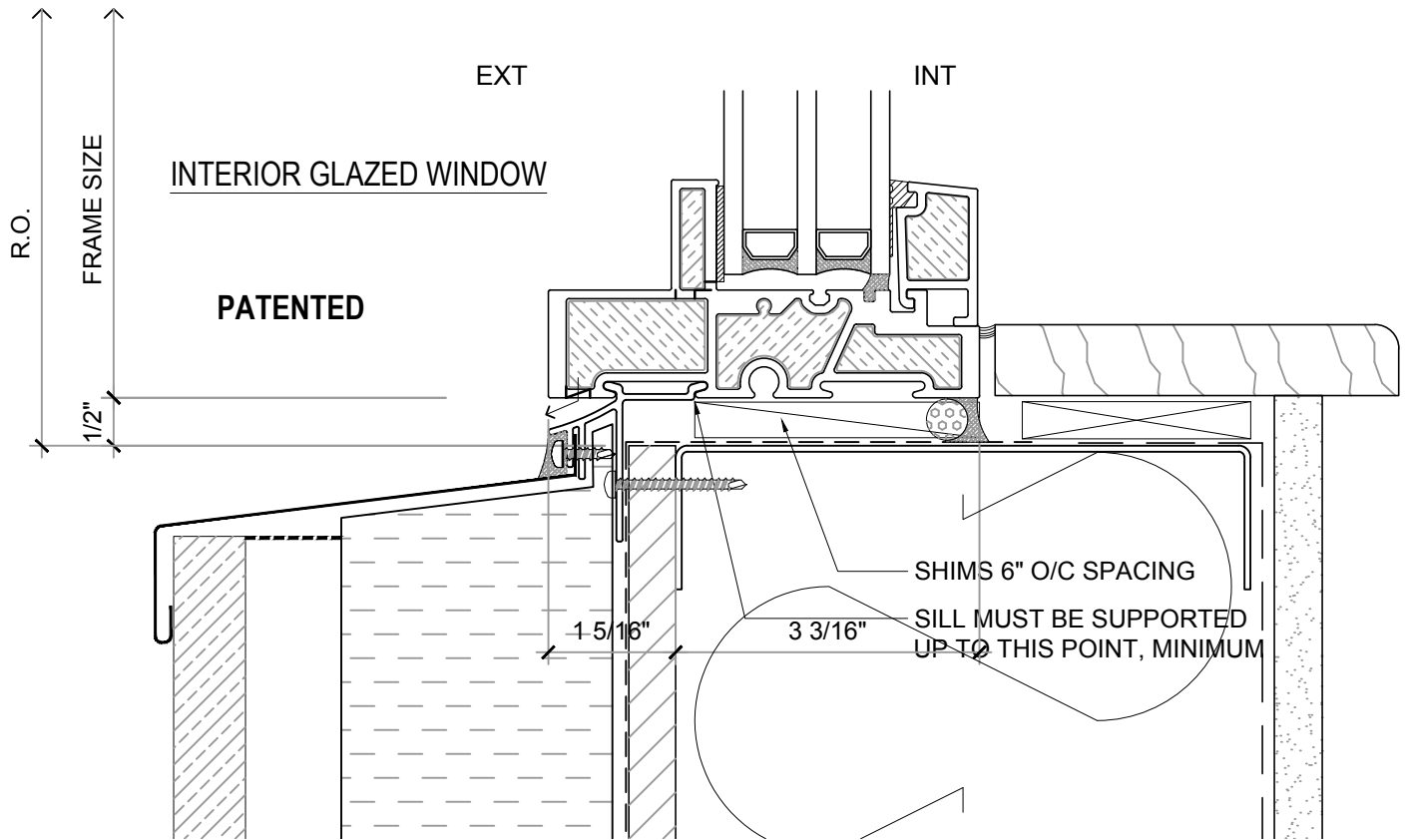

**NOTE:** THIS DRAFT DETAIL IS FOR GENERAL ARRANGEMENT PURPOSES ONLY, AND DOES NOT NECESSARILY REPRESENT A DETAIL THAT IS APPROPRIATE FOR A SPECIFIC PROJECT. PRODUCTS AND ACCESSORIES PROVIDED BY CASCADIA MUST BE CONFIRMED FOR SPECIFIC PROJECTS.

**NOTE:** NAIL FLANGE IS CONTINUOUS

CASCADIA WINDOWS LTD.  
 #101-5350 275TH STREET  
 LANGLEY, BC, CANADA V4W 0C1

DRAWING TITLE: **UNIVERSAL SERIES - WINDOW SILLS**  
**STANDARD NAIL FLANGE INSTALLATION (CW-NF2)**

DRAWING NO.: **NF-1.02**

SCALE: 6" = 1'-0"

PATENTED

DATE: 16 MAY, 2018

DRAWN BY: CP

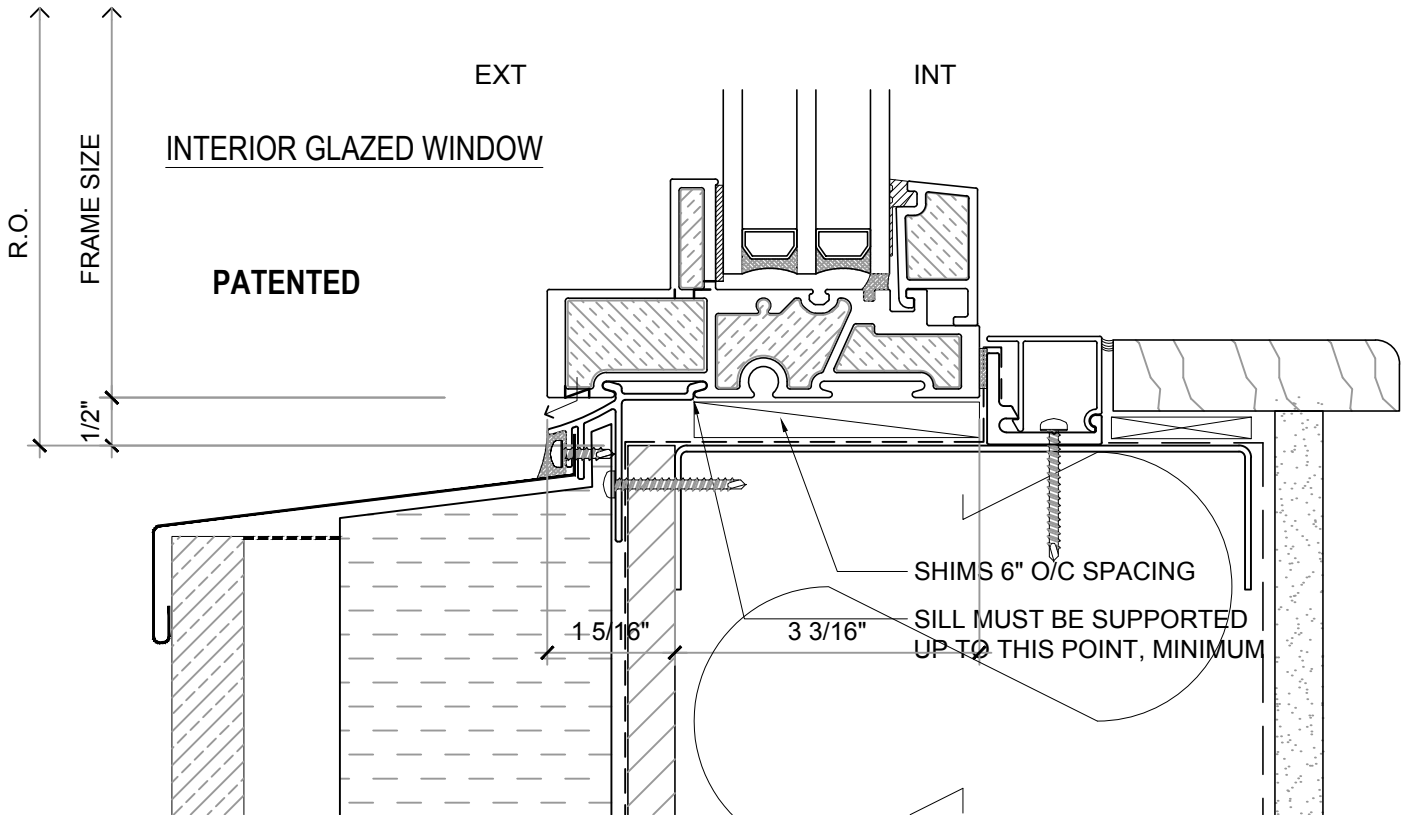

## ALTERNATE SILL DETAILS

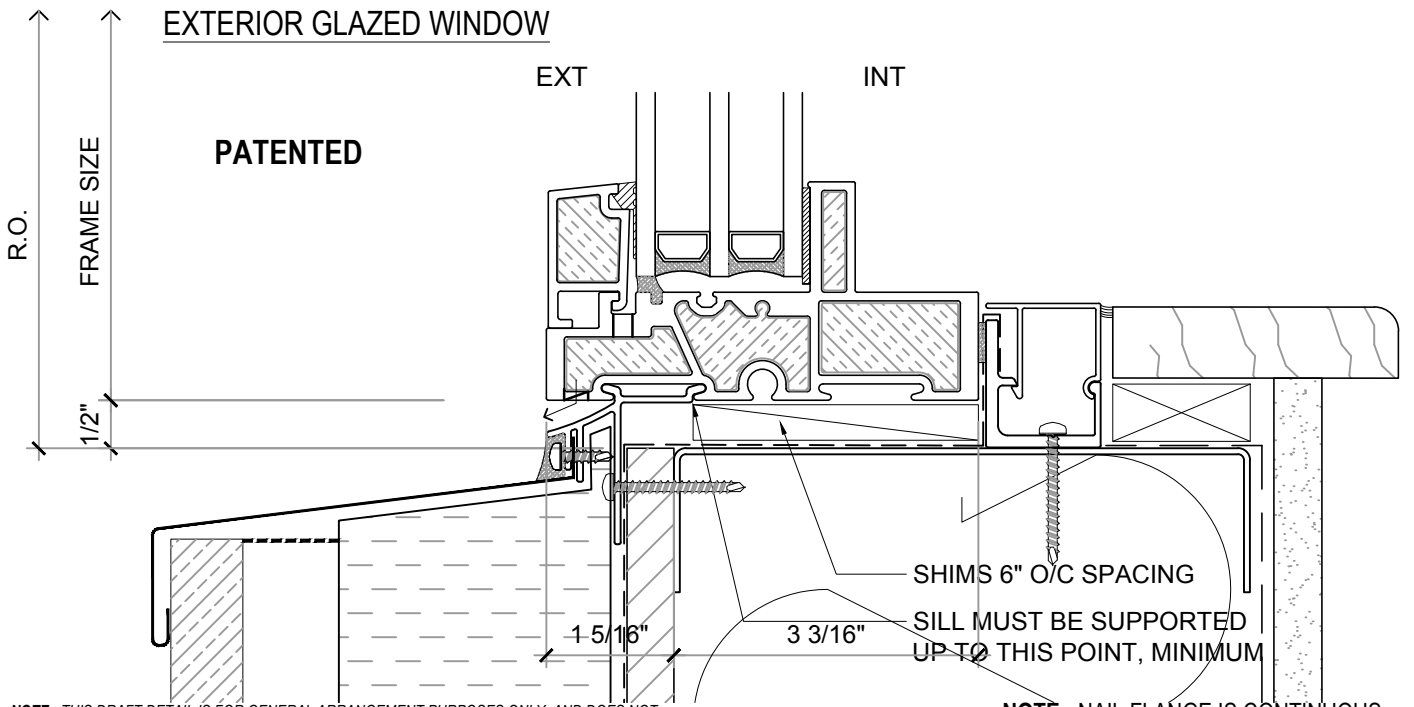

**NOTE:** THIS DRAFT DETAIL IS FOR GENERAL ARRANGEMENT PURPOSES ONLY, AND DOES NOT NECESSARILY REPRESENT A DETAIL THAT IS APPROPRIATE FOR A SPECIFIC PROJECT. PRODUCTS AND ACCESSORIES PROVIDED BY CASCADIA MUST BE CONFIRMED FOR SPECIFIC PROJECTS.

**NOTE:** NAIL FLANGE IS CONTINUOUS

CASCADIA WINDOWS LTD.  
 #101-5350 275TH STREET  
 LANGLEY, BC, CANADA V4W 0C1

DRAWING TITLE: **UNIVERSAL SERIES - WINDOW SILLS**  
**STANDARD NAIL FLANGE INSTALLATION (CW-NF2) & SILL ANGLE**

DRAWING NO.: **NF-1.02A**

SCALE: 6" = 1'-0"

PATENTED

DATE: 16 MAY, 2018

DRAWN BY: CP

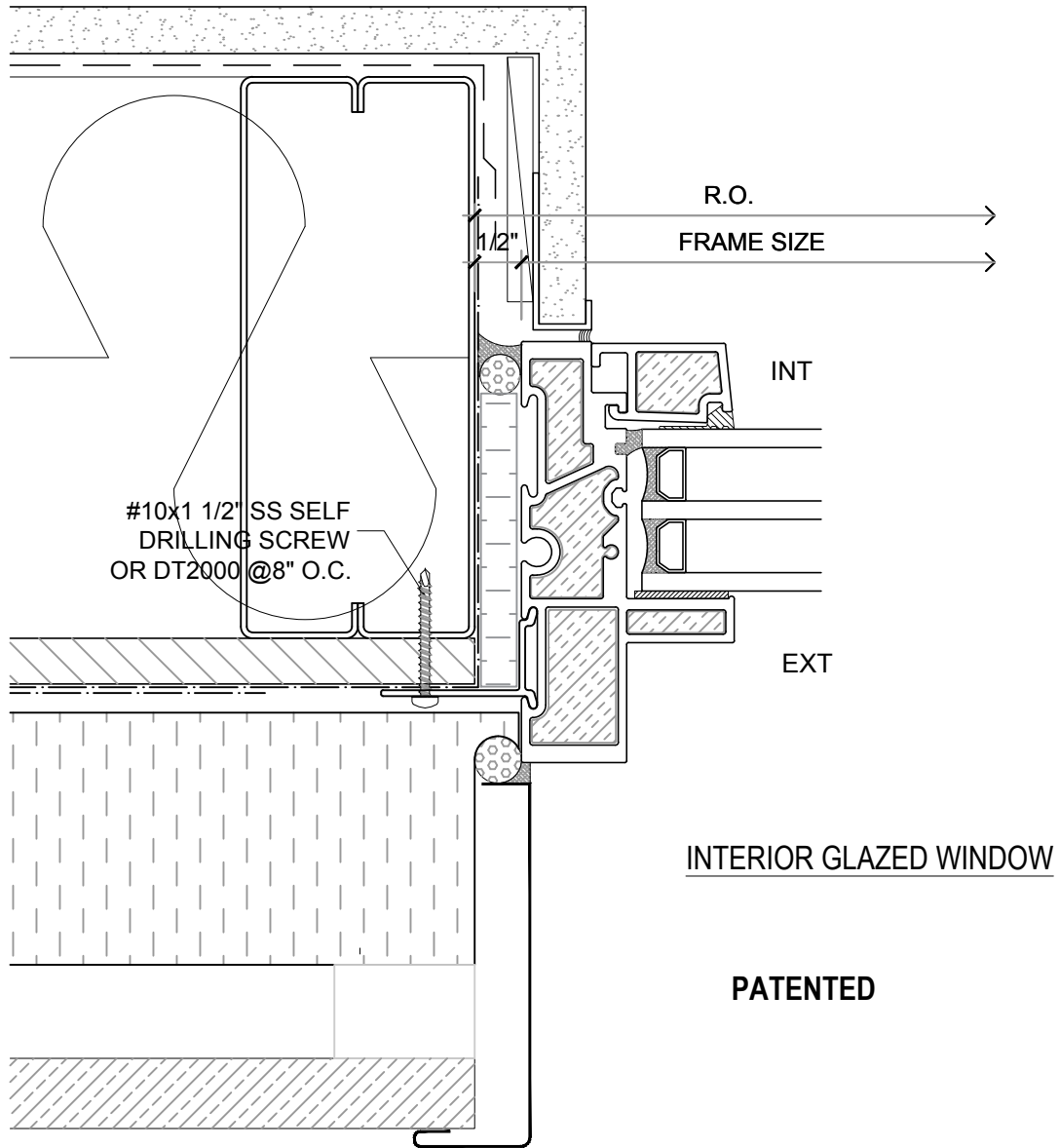

**NOTE:** THIS DRAFT DETAIL IS FOR GENERAL ARRANGEMENT PURPOSES ONLY, AND DOES NOT NECESSARILY REPRESENT A DETAIL THAT IS APPROPRIATE FOR A SPECIFIC PROJECT. PRODUCTS AND ACCESSORIES PROVIDED BY CASCADIA MUST BE CONFIRMED FOR SPECIFIC PROJECTS.

**NOTE:** NAIL FLANGE IS CONTINUOUS

CASCADIA WINDOWS LTD.  
 #101-5350 275TH STREET  
 LANGLEY, BC, CANADA V4W 0C1

DRAWING  
 TITLE:

UNIVERSAL SERIES - WINDOW JAMB  
 STANDARD NAIL FLANGE INSTALLATION (CW-NF1)

DRAWING NO.:

NF-1.03

SCALE: 6" = 1'-0"

PATENTED

DATE: 16 MAY, 2018

DRAWN BY: CP

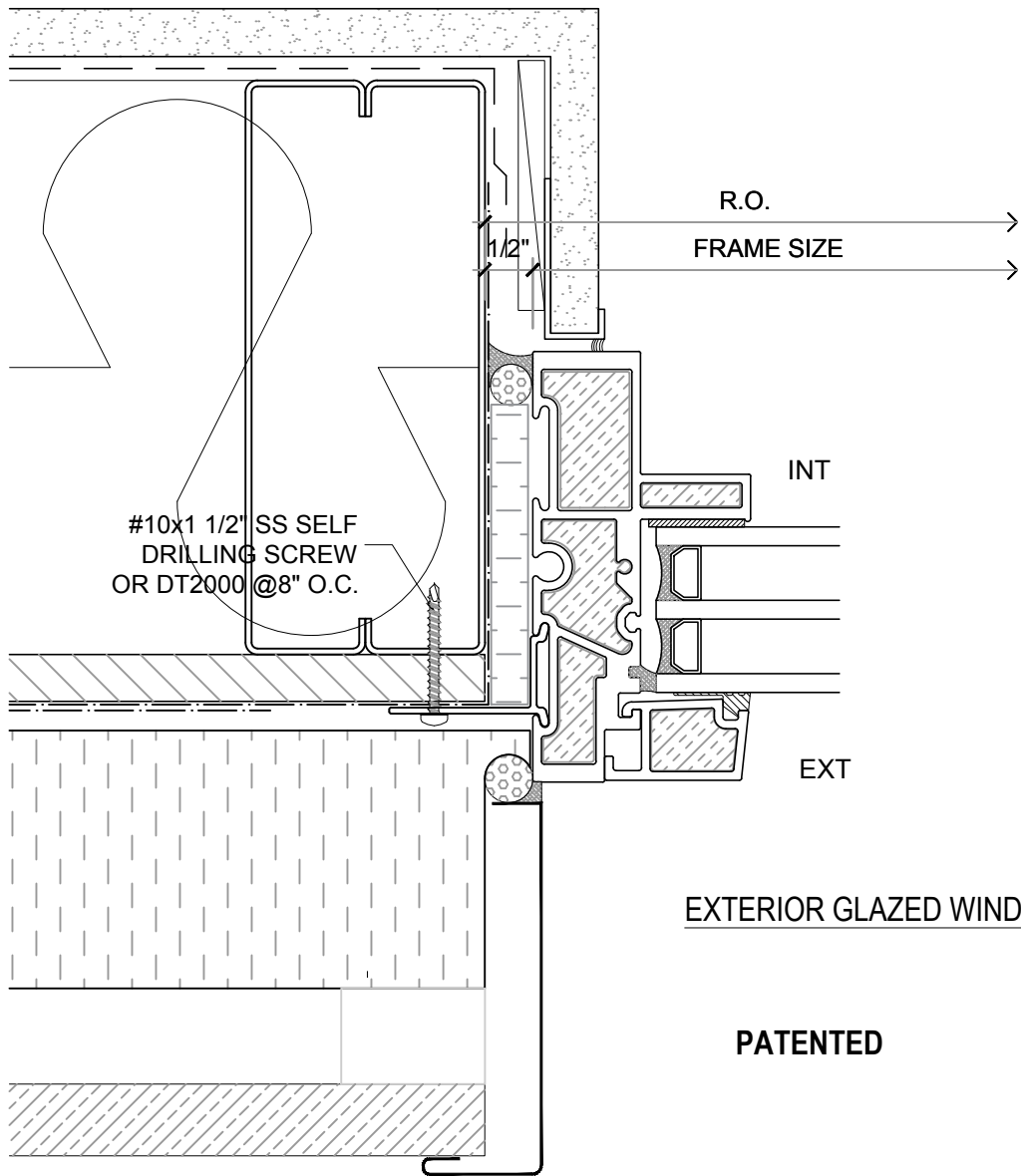

**NOTE:** THIS DRAFT DETAIL IS FOR GENERAL ARRANGEMENT PURPOSES ONLY, AND DOES NOT NECESSARILY REPRESENT A DETAIL THAT IS APPROPRIATE FOR A SPECIFIC PROJECT. PRODUCTS AND ACCESSORIES PROVIDED BY CASCADIA MUST BE CONFIRMED FOR SPECIFIC PROJECTS.

**NOTE:** NAIL FLANGE IS CONTINUOUS

CASCADIA WINDOWS LTD.  
 #101-5350 275TH STREET  
 LANGLEY, BC, CANADA V4W 0C1

DRAWING  
 TITLE:

UNIVERSAL SERIES - WINDOW JAMB  
 STANDARD NAIL FLANGE INSTALLATION (CW-NF1)

DRAWING NO.:

NF-1.04

SCALE: 6" = 1'-0"

PATENTED

DATE: 16 MAY, 2018

DRAWN BY: CP

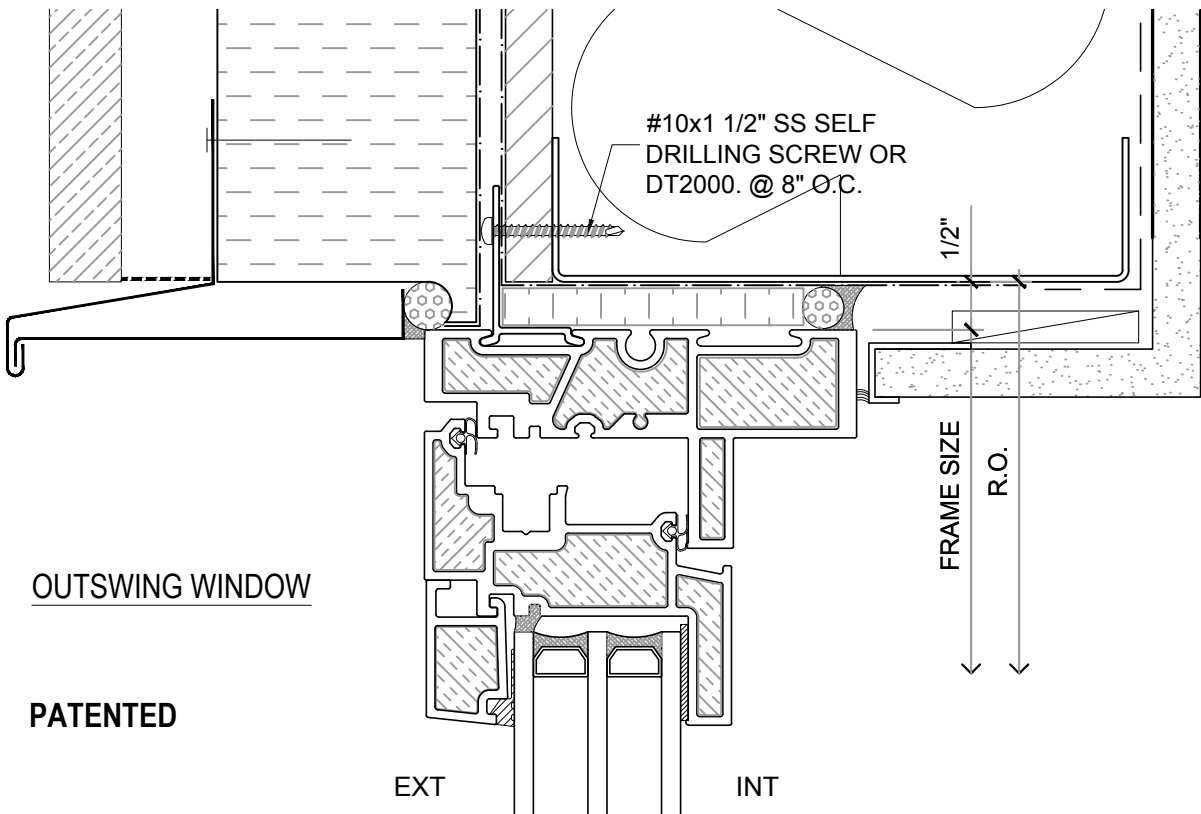
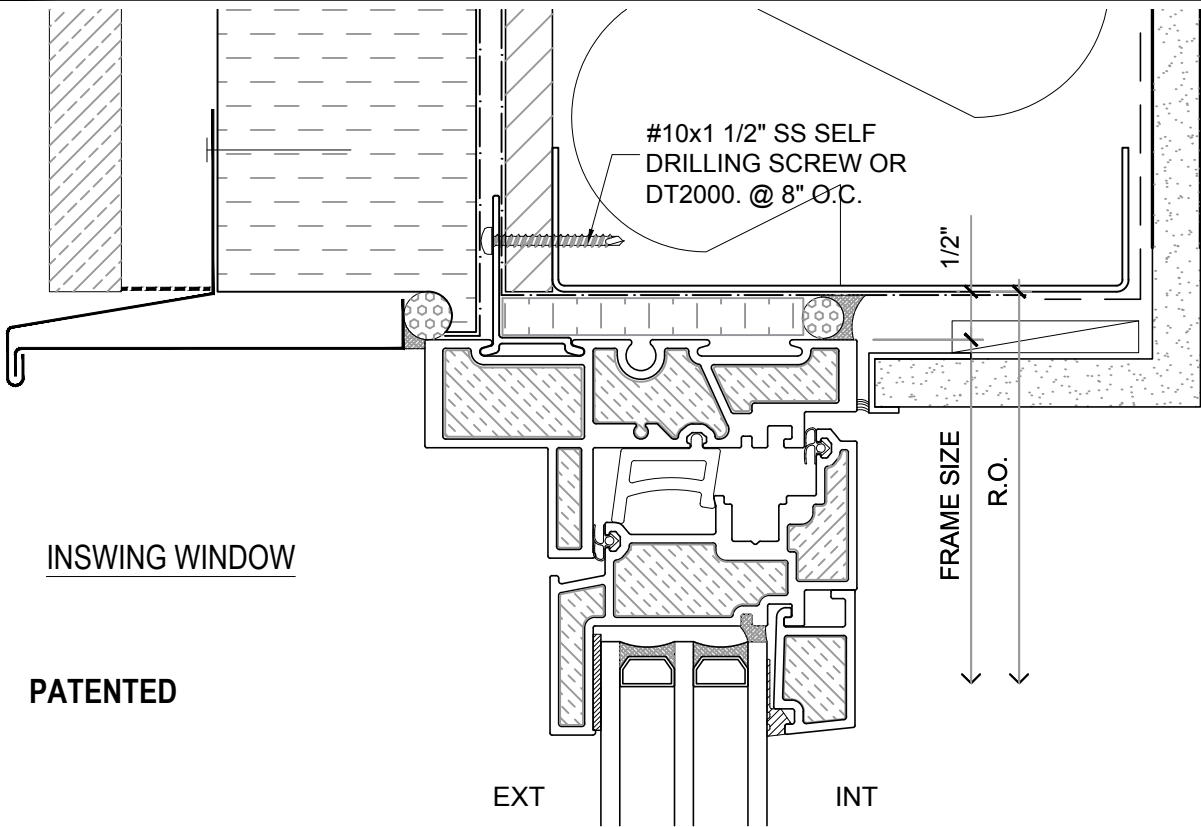

**NOTE:** THIS DRAFT DETAIL IS FOR GENERAL ARRANGEMENT PURPOSES ONLY, AND DOES NOT NECESSARILY REPRESENT A DETAIL THAT IS APPROPRIATE FOR A SPECIFIC PROJECT. PRODUCTS AND ACCESSORIES PROVIDED BY CASCADIA MUST BE CONFIRMED FOR SPECIFIC PROJECTS.

**NOTE:** NAIL FLANGE IS CONTINUOUS

CASCADIA WINDOWS LTD.  
 #101-5350 275TH STREET  
 LANGLEY, BC, CANADA V4W 0C1

DRAWING TITLE: UNIVERSAL SERIES - WINDOW HEADS  
 STANDARD NAIL FLANGE INSTALLATION (CW-NF1)

DRAWING NO.: NF-1.05

SCALE: 6" = 1'-0"

PATENTED

DATE: 16 MAY, 2018

DRAWN BY: CP

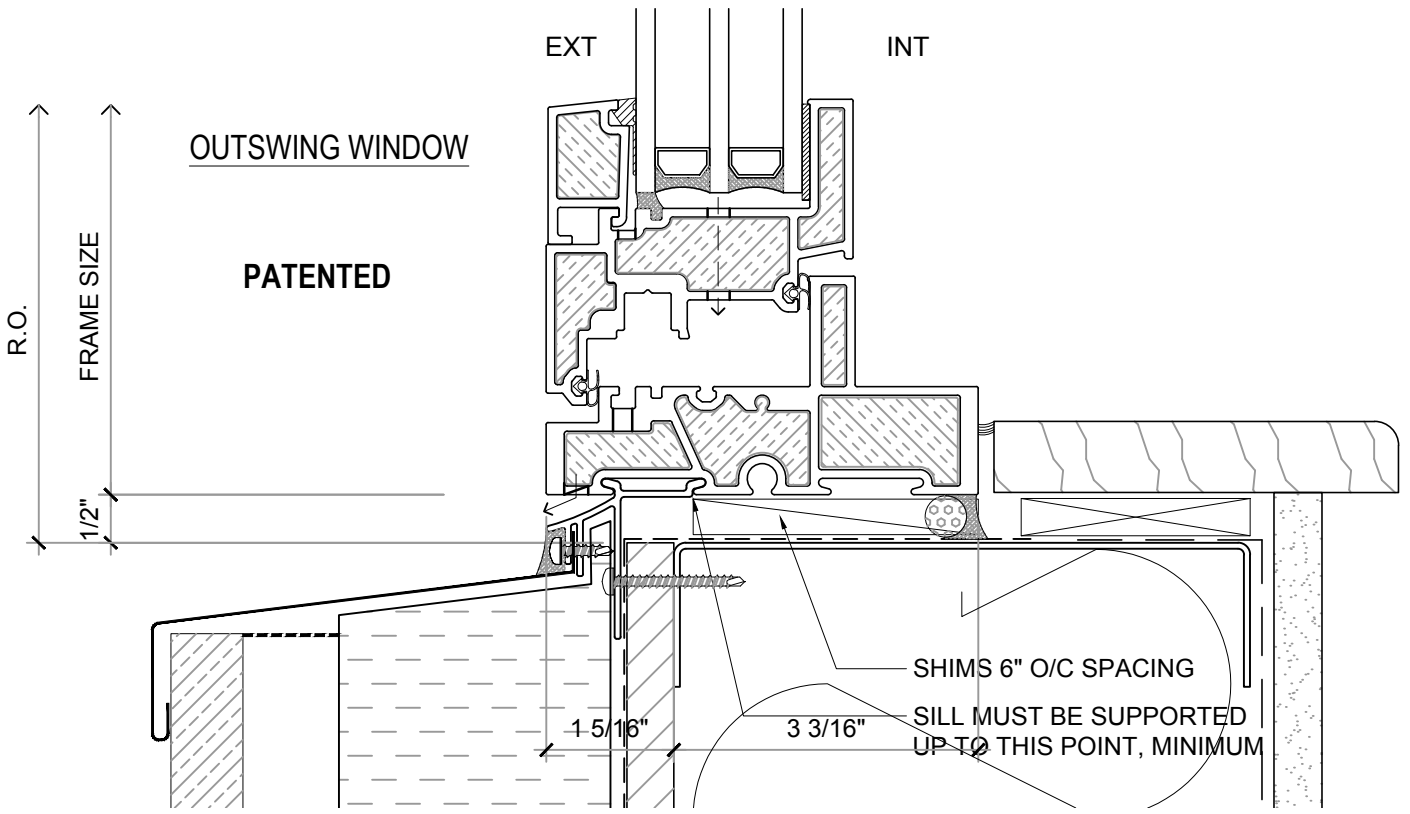
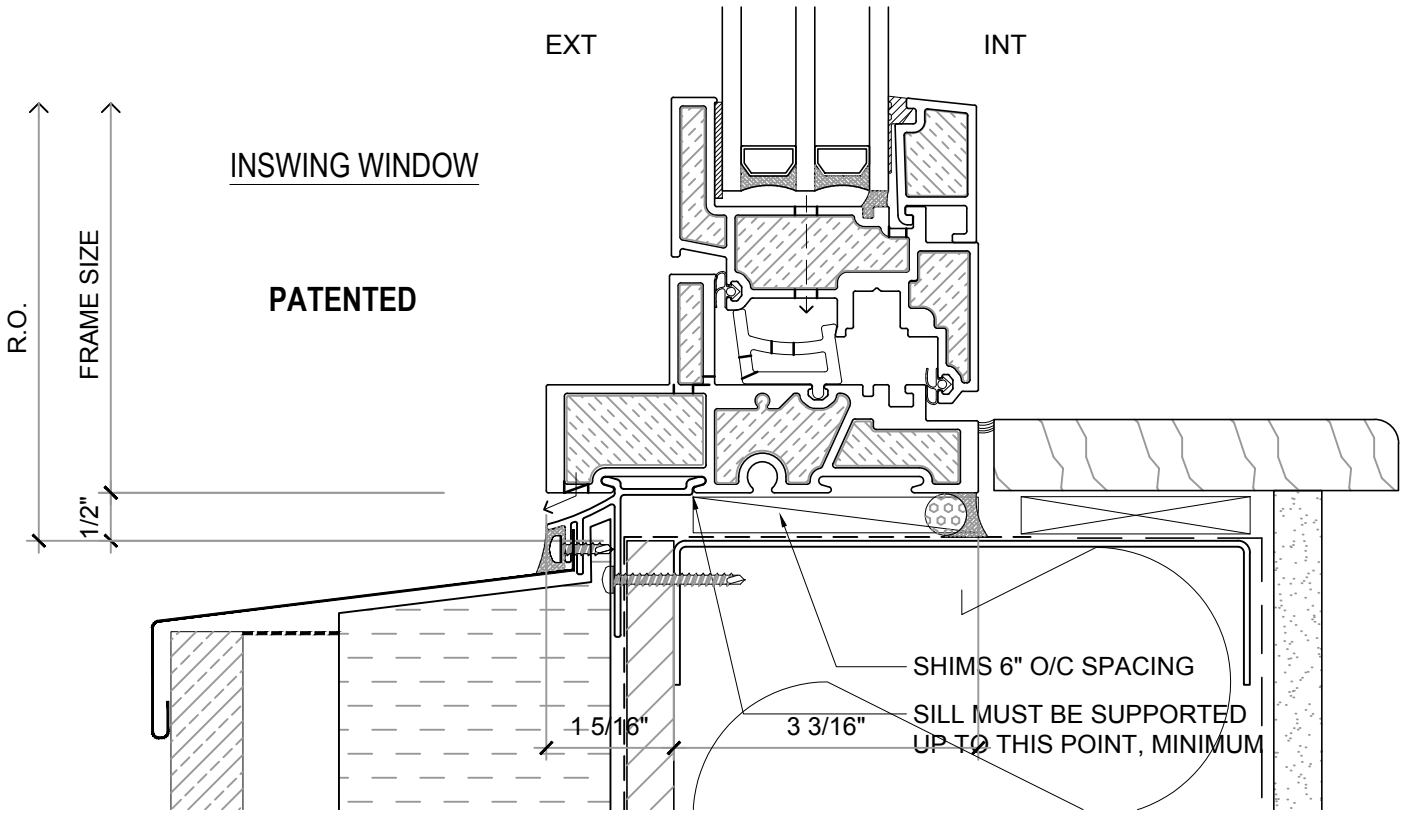

**NOTE:** THIS DRAFT DETAIL IS FOR GENERAL ARRANGEMENT PURPOSES ONLY, AND DOES NOT NECESSARILY REPRESENT A DETAIL THAT IS APPROPRIATE FOR A SPECIFIC PROJECT. PRODUCTS AND ACCESSORIES PROVIDED BY CASCADIA MUST BE CONFIRMED FOR SPECIFIC PROJECTS.

**NOTE:** NAIL FLANGE IS CONTINUOUS

<b>CASCADIA WINDOWS LTD.</b> #101-5350 275TH STREET LANGLEY, BC, CANADA V4W 0C1	DRAWING TITLE: <b>UNIVERSAL SERIES - WINDOW SILLS</b> <b>STANDARD NAIL FLANGE INSTALLATION (CW-NF2)</b>	DRAWING NO.: <b>NF-1.06</b>
	SCALE: 6" = 1'-0"	PATENTED
		DRAWN BY: CP

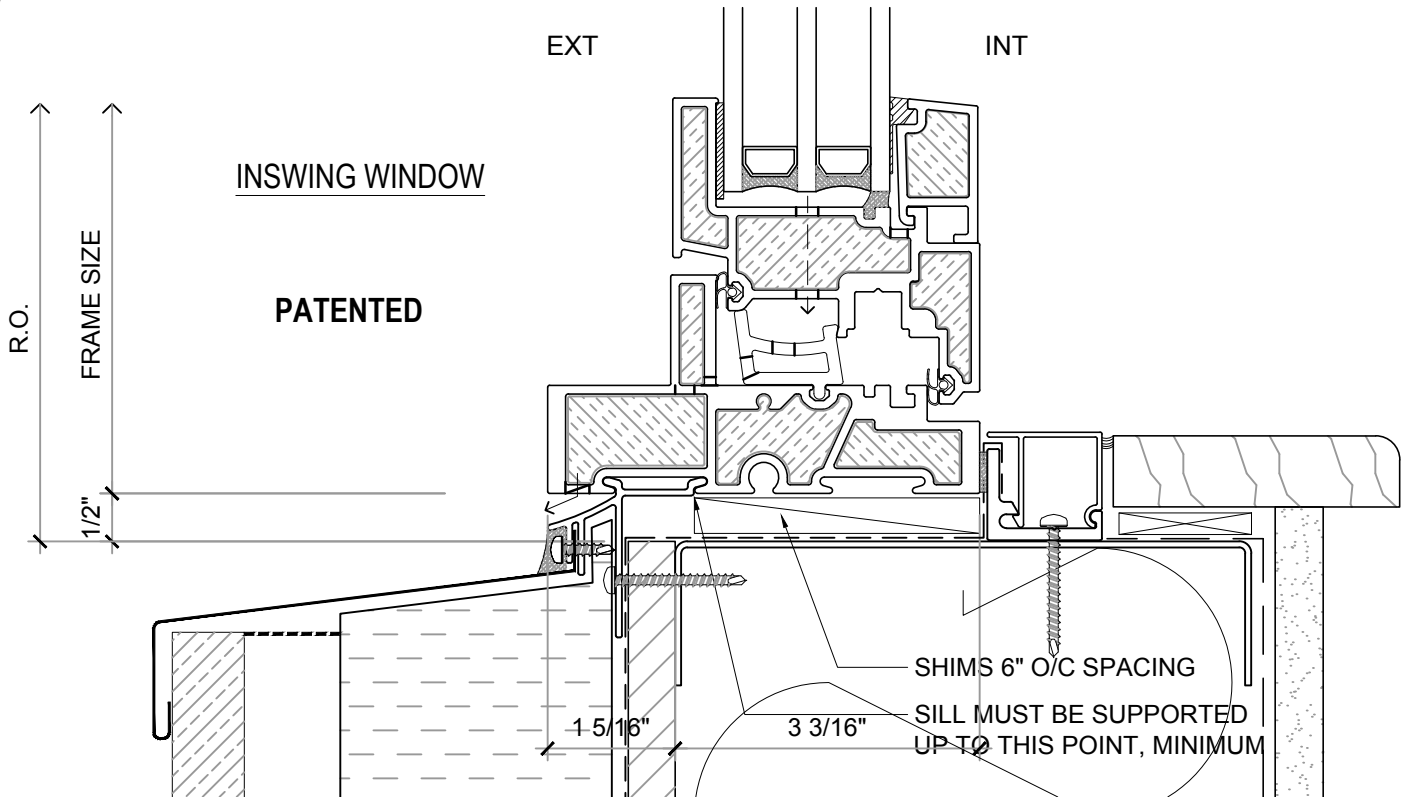

# ALTERNATE SILL DETAILS

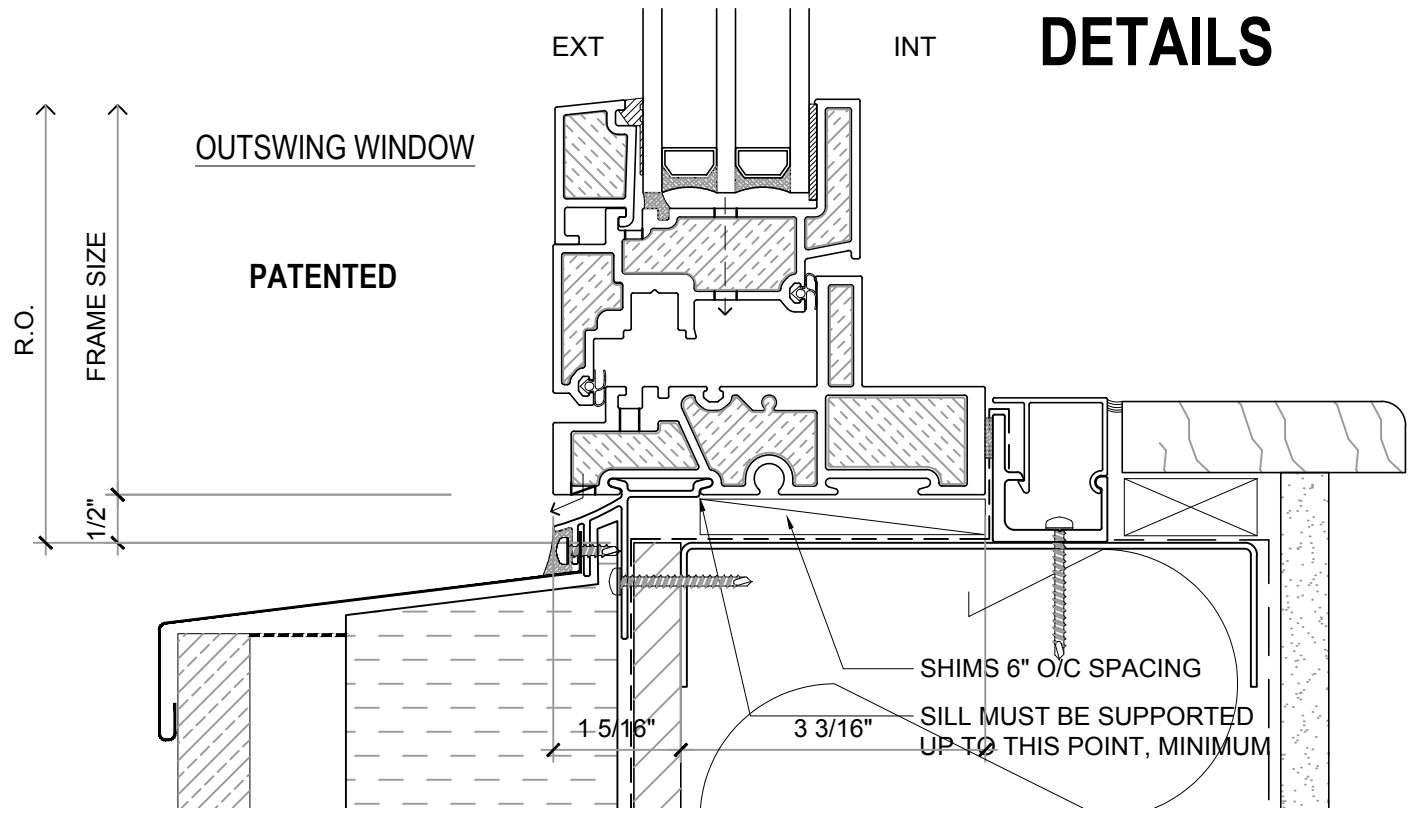

**NOTE:** THIS DRAFT DETAIL IS FOR GENERAL ARRANGEMENT PURPOSES ONLY, AND DOES NOT NECESSARILY REPRESENT A DETAIL THAT IS APPROPRIATE FOR A SPECIFIC PROJECT. PRODUCTS AND ACCESSORIES PROVIDED BY CASCADIA MUST BE CONFIRMED FOR SPECIFIC PROJECTS.

**NOTE:** NAIL FLANGE IS CONTINUOUS

<b>CASCADIA WINDOWS LTD.</b> #101-5350 275TH STREET LANGLEY, BC, CANADA V4W 0C1	DRAWING TITLE: <b>UNIVERSAL SERIES - WINDOW SILLS</b> <b>STANDARD NAIL FLANGE INSTALLATION (CW-NF2)</b>	DRAWING NO.: <b>NF-1.06A</b>
	SCALE: 6" = 1'-0"	PATENTED
		DRAWN BY: CP



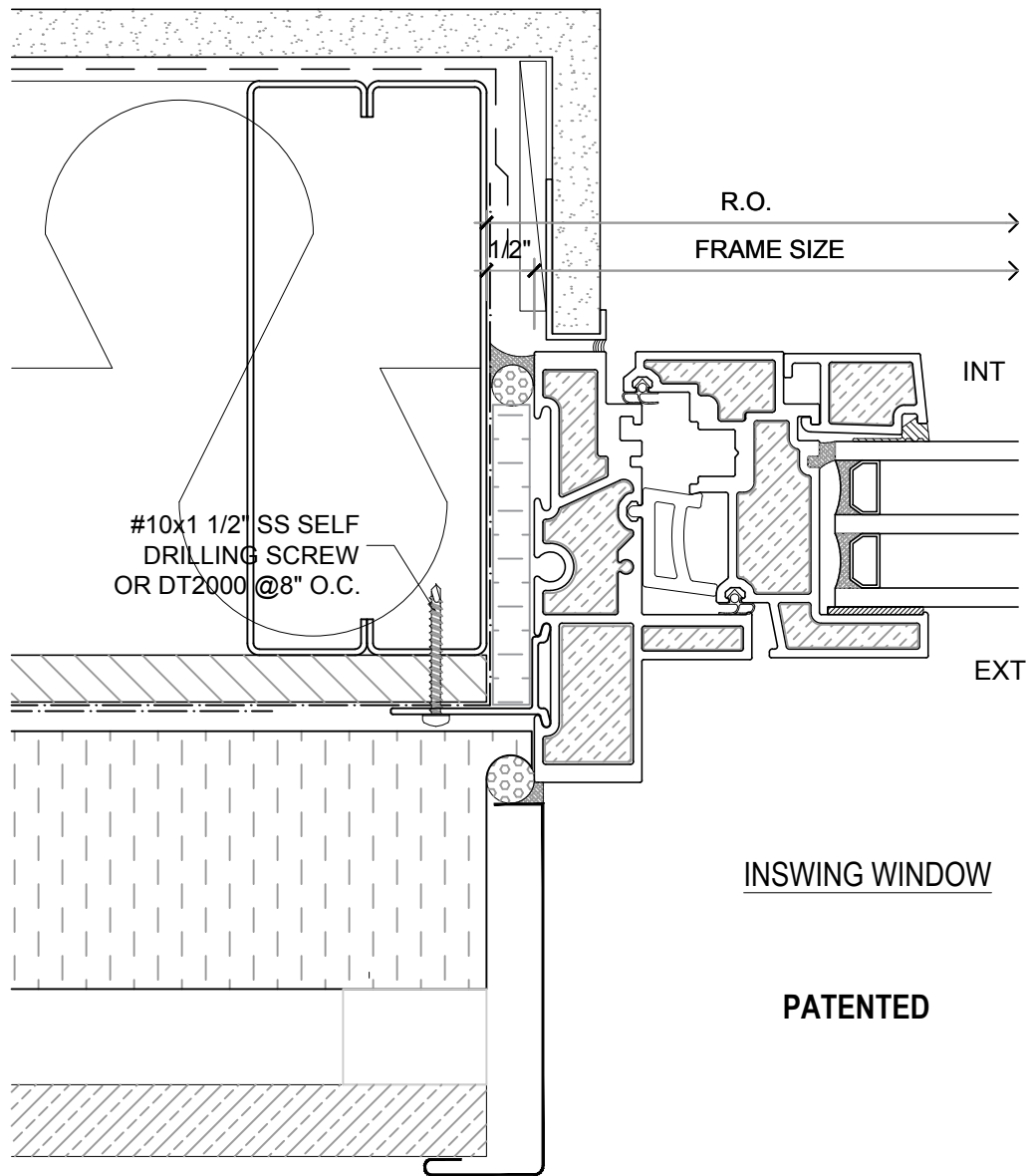

**NOTE:** THIS DRAFT DETAIL IS FOR GENERAL ARRANGEMENT PURPOSES ONLY, AND DOES NOT NECESSARILY REPRESENT A DETAIL THAT IS APPROPRIATE FOR A SPECIFIC PROJECT. PRODUCTS AND ACCESSORIES PROVIDED BY CASCADIA MUST BE CONFIRMED FOR SPECIFIC PROJECTS.

**NOTE:** NAIL FLANGE IS CONTINUOUS

**CASCADIA WINDOWS LTD.**  
#101-5350 275TH STREET  
LANGLEY, BC, CANADA V4W 0C1

DRAWING  
TITLE:

**UNIVERSAL SERIES - WINDOW JAMB**  
**STANDARD NAIL FLANGE INSTALLATION (CW-NF1)**

DRAWING NO.:

**NF-1.07**

SCALE: 6" = 1'-0"

PATENTED

DATE: 16 MAY, 2018

DRAWN BY: CP

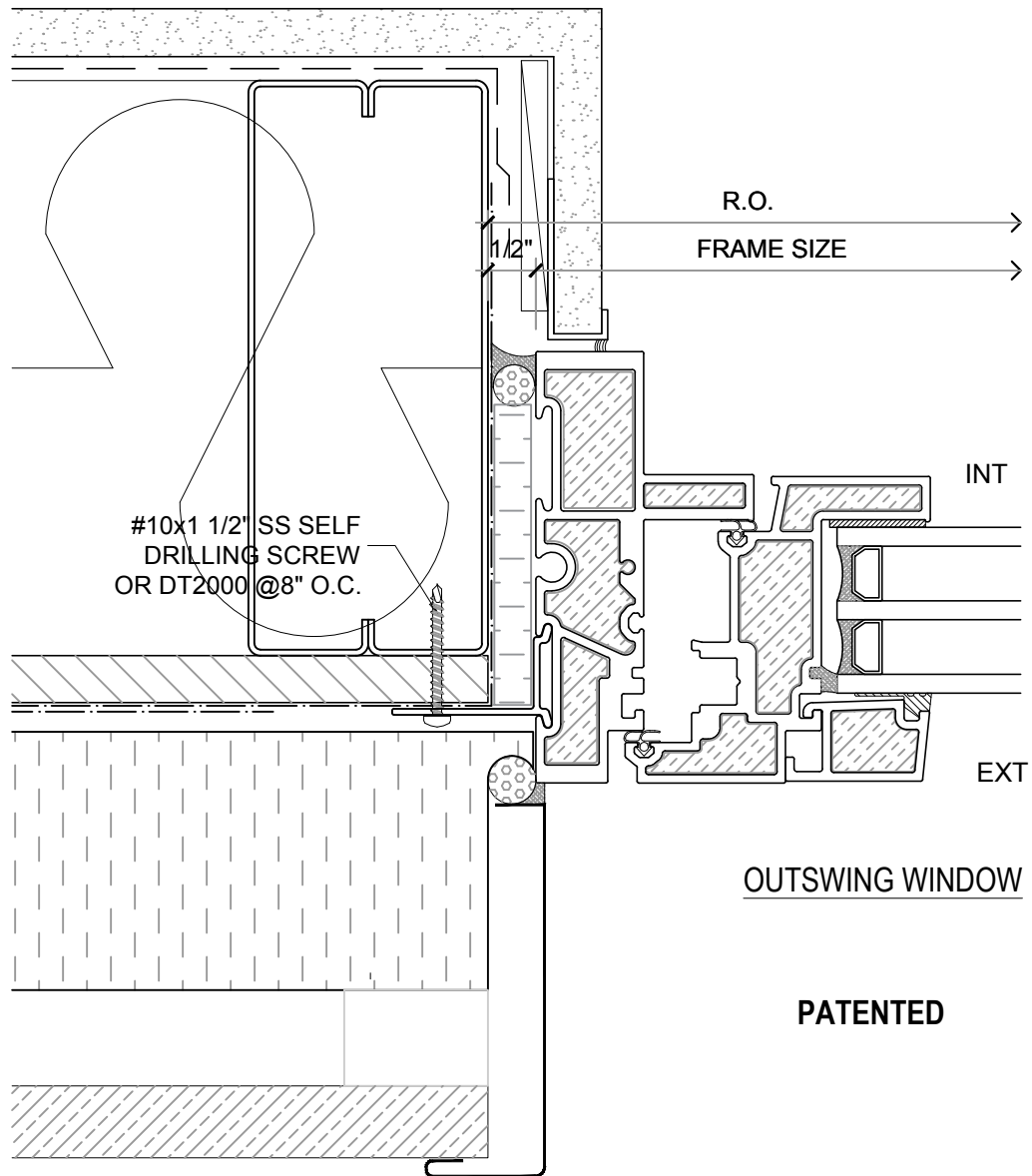

**NOTE:** THIS DRAFT DETAIL IS FOR GENERAL ARRANGEMENT PURPOSES ONLY, AND DOES NOT NECESSARILY REPRESENT A DETAIL THAT IS APPROPRIATE FOR A SPECIFIC PROJECT. PRODUCTS AND ACCESSORIES PROVIDED BY CASCADIA MUST BE CONFIRMED FOR SPECIFIC PROJECTS.

**NOTE:** NAIL FLANGE IS CONTINUOUS

**CASCADIA WINDOWS LTD.**  
 #101-5350 275TH STREET  
 LANGLEY, BC, CANADA V4W 0C1

DRAWING TITLE: **UNIVERSAL SERIES - WINDOW JAMB**  
**STANDARD NAIL FLANGE INSTALLATION (CW-NF1)**

DRAWING NO.: **NF-1.08**

SCALE: 6" = 1'-0"

PATENTED

DATE: 16 MAY, 2018

DRAWN BY: CP