

UNIVERSAL SERIES™

Operation Guide - Tilt & Turn Window (Tilt Function)

TILTING THE WINDOW



1. Turn the handle to the up position.



2. Gently pull the handle to tilt the window inward.

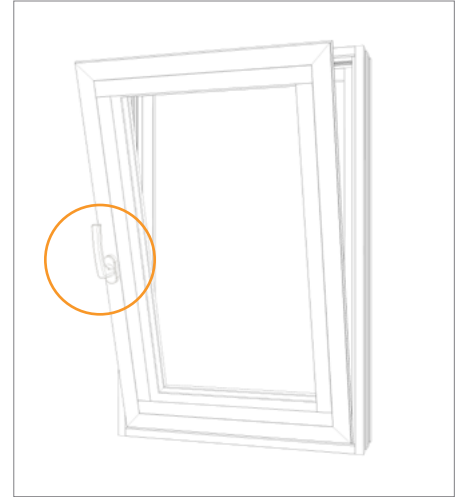

3. Leave handle in the up position.

CLOSING THE WINDOW FROM TILT POSITION

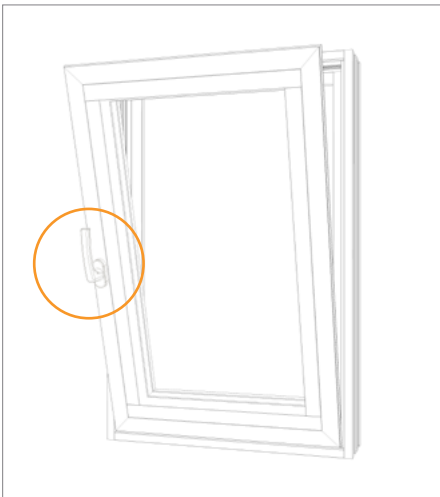

1. Ensure handle is in the up position.

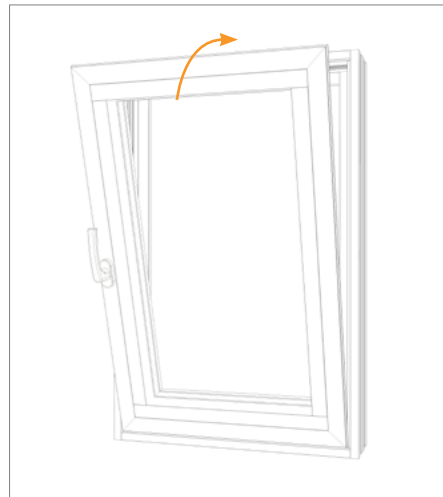

2. Gently push the handle to tilt the window outward until fully closed.

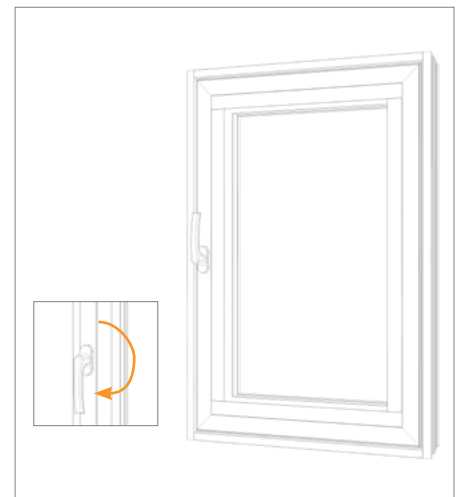

3. Turn the handle to the down position.

UNIVERSAL SERIES™

Operation Guide - Tilt & Turn Window (Turn Function)

OPENING THE WINDOW

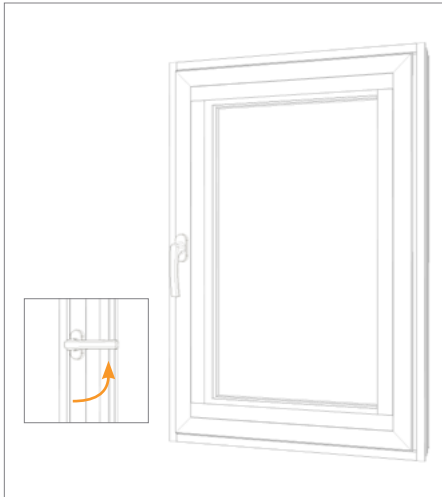

1. Turn this handle to horizontal.



2. Gently pull the handle inward.

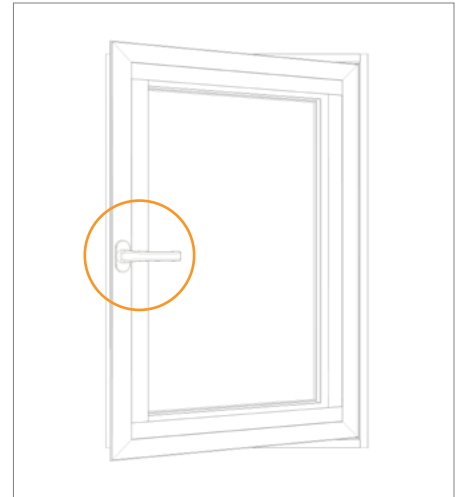

3. Leave handle at horizontal.

CLOSING THE WINDOW

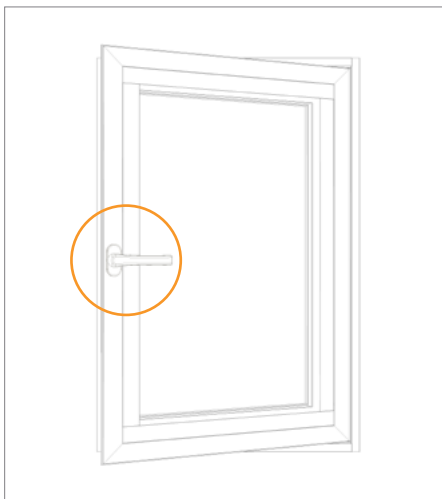

1. Ensure handle is at horizontal.

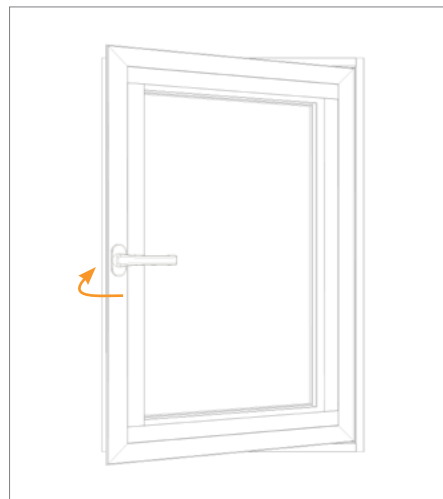

2. Gently push the handle outward until window is fully closed.

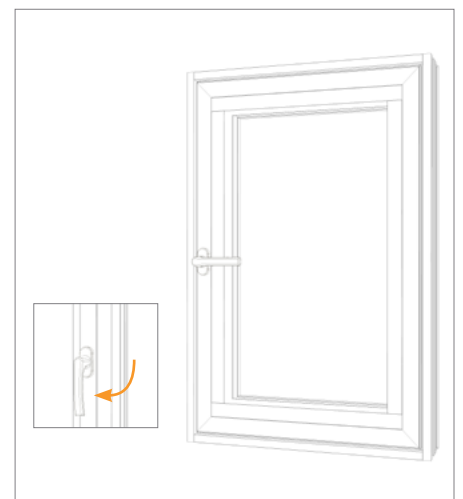

3. Turn the handle to the down position.

UNIVERSAL SERIES™

Operation Guide - Tilt & Turn Window (Correcting mishandling)

Tilt and turn windows can experience a situation called mishandling. This can occur if the user partially closes the window (during the turn function) and tries to activate the tilt function. This results in the window 'pivoting' at the bottom corner and will not correct itself by simply closing the window.

If mishandling occurs, it can be easily corrected through the following steps.

CORRECTING A MISHANDLING



1. If a mishandling occurs, locate the mishandling device on the sash frame, adjacent to the handle.

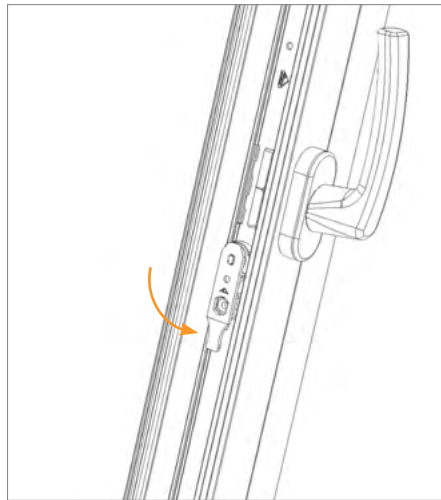

2. Manually press the mishandling device until it is in a vertical, downward position.

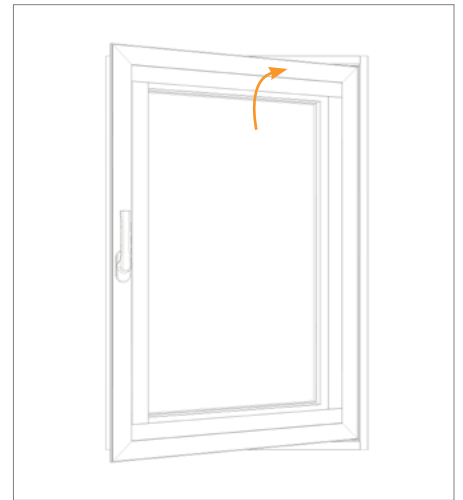

3. While holding the mishandling device in a vertical downward position, manually push the top of the sash closed.

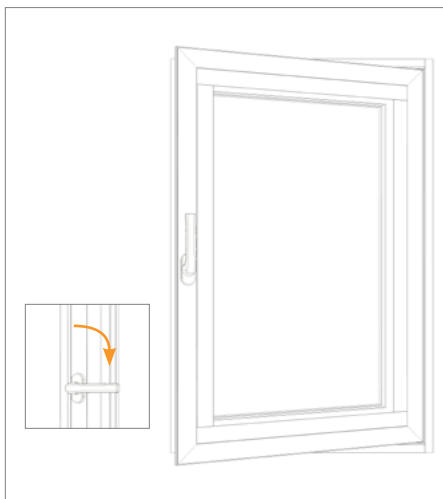

4. While continuing to hold the mishandling device, return the handle to the horizontal position.

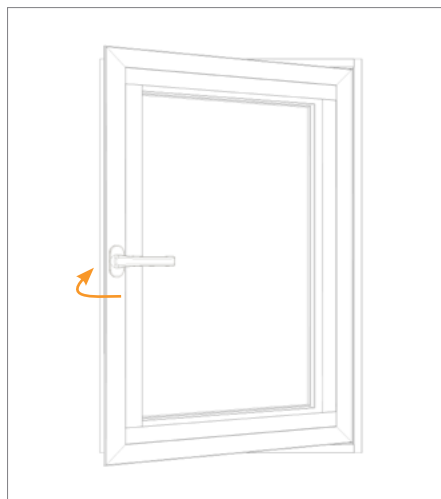

5. Gently push the handle outward until window is fully closed.

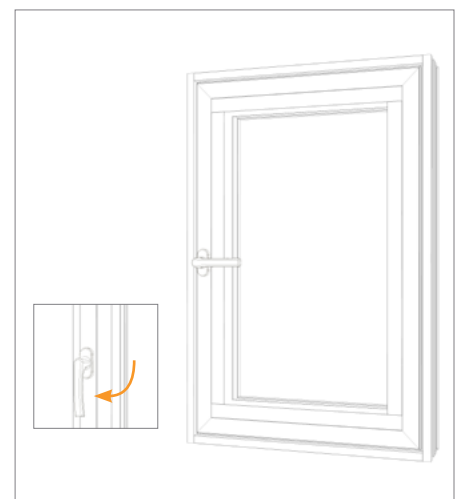

6. Turn the handle to the down position.